



MAGNETI PERMANENTI permanent magnets



garnet



INDUSTRIAL SOLUTIONS

FICOPA (Recinto Ferial Gipuzkoa)
AVDA. IPARRALDE, 43 - ROOM 3
20302 IRUN-GIPUZKOA (SPAIN)

☎ 00 34 646 211965

✉ RCC@RCCINDUSTRIAL.COM

📍 [RCCINDUSTRIAL](https://www.rccindustrial.com)

WWW.RCCINDUSTRIAL.COM



garnet

Garnet Srl

Via Magellano 14 - 20863 Concorezzo (MB)
Tel. +39 039 6886158 - Fax +39 039 6908081
info@garnet.it - www.garnet.it

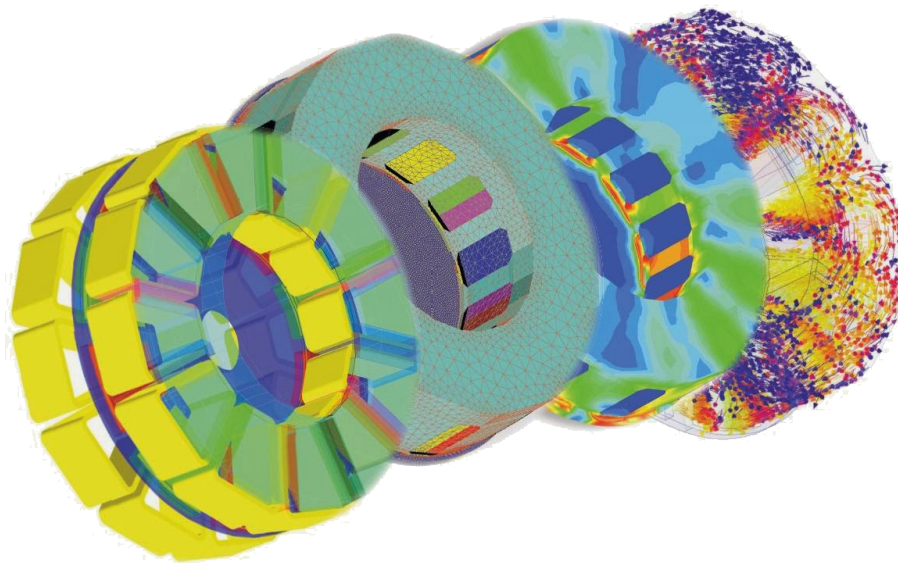

garnet



Garnet S.r.l. è presente da quasi 20 anni sul mercato italiano ed internazionale e collabora con aziende leader a livello mondiale nella produzione di magneti permanenti sinterizzati e plastici.

Grazie a tali partnership, Garnet vanta una vasta gamma di prodotti e servizi altamente competitivi, offrendo una tecnologia avanzata in continuo sviluppo, con un supporto tecnico costante nei confronti del cliente.

Garnet attribuisce grande importanza alla certificazione e alla qualità dei prodotti finiti, scegliendo partner che garantiscono alti livelli di affidabilità e che operano con unità produttive certificate ISO9000 e QS9000.

La presenza di una rete tecnico-commerciale qualificata è in grado di soddisfare ogni esigenza del cliente, dallo sviluppo dei prototipi fino alla produzione di serie, sia nel caso di prodotti standard che custom.



Garnet S.r.l. has been active for almost 20 years on the Italian and worldwide market, working together with international leader companies in the field of sintered and plastic permanent magnets production.

Thanks to these partnerships, Garnet can boast a wide range of highly competitive products and services and offers developing advanced technology, with constant technical support for its customers.

Garnet is deeply concerned with the certification and quality of the final products, selecting partners who guarantee high reliability and work with ISO9000 and QS9000 certified plants.

The presence of a qualified technical support team allows Garnet to identify appropriate solutions for any need of the customer, from the prototype design to the final production, both with standard and custom products.

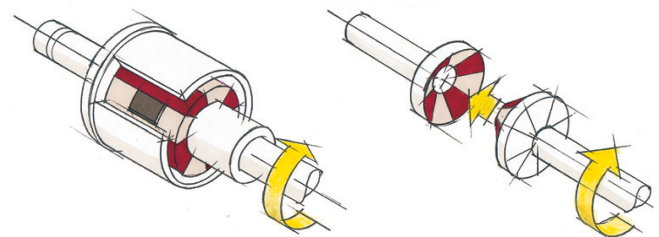



NEODYMIUM-IRON-BORON

Alloys of Rare Earth materials, NdFeB magnets are the most advanced commercialized permanent magnets in the market.

Thanks to the possibility of magnetising them in any direction and to their strong resistance to demagnetisation, these magnets can be used where high performance is required.



NEODIMIO-FERRO-BORO

Composti di polveri di terre rare, i magneti in Neodimio-Ferro-Boro (NdFeB) sono tra i più potenti e avanzati disponibili sul mercato. Grazie alla possibilità di magnetizzarli in qualsiasi direzione e all'alta resistenza alla smagnetizzazione, essi possono essere utilizzati in applicazioni dove si richiedono ottime prestazioni e performance molto elevate.

SAMARIUM-COBALT

Though less strong and more expensive than NdFeB, these Rare Earth magnets (an alloy of Samarium and Cobalt) can be used in many applications due to their vastly superior technical performance (working temperature up to 350°C) and corrosion resistance.

These materials are brittle, and machining operations should be performed using diamond tools.



SAMARIO-COBALTO

Sebbene meno potenti ed economici del NdFeB, questi magneti in terre rare (derivanti da una lega tra Samario e Cobalto; SmCo) trovano largo utilizzo in una vasta gamma di applicazioni grazie alla loro elevata resistenza alle alte temperature (fino a 350°C) e alla corrosione.

A causa delle eccezionali caratteristiche del materiale, questi magneti possono essere lavorati solo con utensili diamantati.

ALNICO

AlNiCo magnets, composed of alloys of Aluminium, Nickel and Cobalt, are characterised by excellent temperature stabilities (up to 500°C), high residual inductions and good mechanical resistance.

Though easily demagnetised and rather expensive, these materials offer specific advantages in certain critical applications.



ALNICO

I magneti AlNiCo, composti da una lega di Alluminio, Nichel e Cobalto, sono caratterizzati da un'eccellente resistenza alle alte temperature (fino a 500°C), da alte induzioni residue e da un'estrema solidità meccanica del materiale.

Nonostante la bassa resistenza alla smagnetizzazione, questo materiale offre specifici vantaggi in applicazioni critiche.

SINTERED FERRITE

Sintered ferrite (ceramic) magnets can be used in a vast range of applications. They have the popular advantage of low cost, and are rather resistant to corrossions. If used correctly, the magnetic properties can be very resistant in time. For these reasons ferrites are the most widely used permanent magnets today.



FERRITE SINTERIZZATA

I magneti in ferrite sinterizzata (ceramica) possono essere utilizzati in una vasta gamma di applicazioni. Vantano un ottimo rapporto qualità-prezzo e sono piuttosto resistenti alla corrosione.

Se usati correttamente, le proprietà magnetiche possono resistere per lunghissimi periodi.

Per questi motivi le ferrite sono i magneti permanenti più usati al mondo.



BONDED PLASTO-NEODYMIUM

Obtained through cold compression of NdFeB powders and thermoplastic elements, these magnets can offer the highest performance among plasto-magnets. Thanks to the possibility of achieving semi-complex shapes, to a certain flexibility in magnetizing direction and to a good resistance to high temperatures (+150°C), they can be used in applications where a good magnetic performance (Br up to 7.5 kGs) and reduced costs are required.



PLASTO-NEODIMIO COMPRESSO

Ottenuti tramite processo di compressione a freddo di polveri di NdFeB e matrici termoplastiche, questi magneti sono i più performanti nella famiglia dei plasto-magneti. Grazie alla possibilità di realizzare forme semi-complesse, alla libertà nella magnetizzazione e ad una buona resistenza alle alte temperature (+150°C), sono utilizzati in applicazioni in cui è richiesta una buona performance magnetica (Br fino a 7.5 kGs) affiancata a costi ridotti.

INJECTED PLASTO-NEODYMIUM

Made by injection moulding of NdFeB powders and plastic materials, these plasto-magnets can guarantee a good resistance to high temperatures (up to +120°C), a satisfactory mechanical resistance, and they can offer complex shapes. A very important characteristic of these magnets is the possibility to overmould and magnetize according to the customers' specifications, thereby creating a complete system, such as rotors or shaft impellers.



PLASTO-NEODIMIO INIETTATO

Realizzati tramite stampaggio ad iniezione di polveri di NdFeB e materiali plastici, hanno una buona resistenza alle alte temperature (fino a 120°C), una discreta resistenza meccanica e offrono la possibilità di creare forme complesse. Un'altra caratteristica importante è costituita dalla possibilità di sovrastampare e magnetizzare secondo specifiche, creando un sistema completo, come rotori o giranti già completi di albero.

INJECTED PLASTO-FERRITE

These plasto-magnets are made by injection of ferrite powders and plastic elements. They can offer the same mechanical characteristics and the same possibility to personalize shapes and magnetizing direction as injected plasto-Neodymium. However, these magnets have lower performing properties (Br up to 2.9 kGs) but are more cost-effective and can be used in a wider range of applications.



PLASTO-FERRITE INIETTATA

Plasto-magneti realizzati tramite iniezione di polveri di ferrite e matrici plastiche. Le caratteristiche meccaniche, così come la possibilità di personalizzare forme e magnetizzazioni, sono le stesse del plasto neodimio iniettato. Questi plasto-magneti tuttavia hanno proprietà meno performanti (Br fino a 2.9 kGs), ma sono disponibili a prezzo inferiore e possono essere utilizzati in una vasta gamma di applicazioni.

MAGNETIC RUBBER

Composed of ferrite powder and synthetic rubber or PVC, these flexible materials combine good magnetic properties and cost effectiveness. Their flexibility and machinability (these magnets can be bent, coiled and punched) permit their usage in design and automation field where it is not possible to employ rigid or brittle materials.

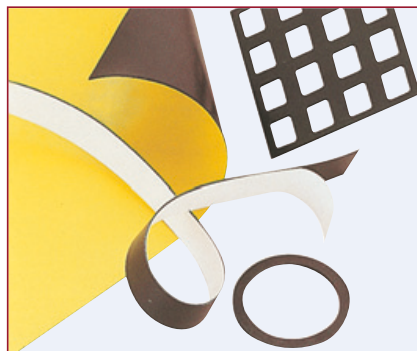

GOMMA MAGNETICA

Composti da polveri di ferrite e gomma sintetica o PVC, questi materiali flessibili abbinano buone capacità magnetiche e costi molto bassi. La flessibilità e la facile lavorazione di questi materiali, che possono essere piegati, arrotolati e forati, permettono l'utilizzo in applicazioni nel campo dell'automazione e del design dove materiali magnetici duri o fragili non possono essere adottati.

SINTERED NEODYMIUM- IRON-BORON



NEODIMIO- FERRO-BORO SINTERIZZATO

NdFeB magnets are an alloy made of rare earths (Neodymium, Iron, Boron and other trace metal elements). Within this class of magnets are a number of different grades which span a wide range of properties and application requirements. Due to the high Iron content, it is recommended to coat the part in order to avoid oxidation.



I magneti in NdFeB sono leghe di terre rare (Neodimio, Ferro, Boro e tracce di altri metalli). Questa categoria di magneti presenta diversi "grade" di materiale, che coprono una vasta gamma di proprietà e rispondono a varie esigenze applicative. A causa della presenza di ferro, questi magneti sono soggetti a ossidazione, pertanto è consigliabile un rivestimento.

Materiale Grade	Induzione residua Remanence B _r		Coercitività Coercivity H _c		Coercitività Intrinseca Intrinsic Coercivity H _{ci}		Prodotto d'Energia Max. Energy Product BH _{MAX}		Temperatura max. di funzion. Max. Operating Temperature T _{MAX} °C
	mT	kGs	kA/m	kOe	kA/m	kOe	kJ/m ³	MGOe	
N27	1030-1080	10.3-10.8	796	10.0	955	12	199-231	25-29	80
N28UH	1020-1080	10.2-10.8	764	9.6	1990	25	207-231	26-29	180
N28EH	1040-1090	10.4-10.9	780	9.8	2388	30	207-231	26-29	200
N30	1080-1130	10.8-11.3	796	10.0	955	12	223-247	28-31	80
N30M	1080-1130	10.8-11.3	796	10.0	1114	14	223-247	28-31	100
N30H	1080-1130	10.8-11.3	796	10.0	1353	17	223-247	28-31	120
N30SH	1080-1130	10.8-11.3	804	10.1	1592	20	223-247	28-31	150
N30UH	1080-1130	10.8-11.3	812	10.2	1990	25	223-247	28-31	180
N30EH	1080-1130	10.8-11.3	812	10.2	2388	30	223-247	28-31	200
N33	1130-1170	11.3-11.7	836	10.5	955	12	247-263	31-33	80
N33M	1130-1170	11.3-11.7	836	10.5	1114	14	247-263	31-33	100
N33H	1130-1170	11.3-11.7	836	10.5	1353	17	247-271	31-34	120
N33SH	1130-1170	11.3-11.7	844	10.6	1592	20	247-271	31-34	150
N33UH	1130-1170	11.3-11.7	852	10.7	1990	25	247-271	31-34	180
N33EH	1130-1170	11.3-11.7	836	10.5	2388	30	247-271	31-34	200
N35	1170-1220	11.7-12.2	868	10.9	955	12	263-287	33-36	80
N35M	1170-1220	11.7-12.2	868	10.9	1114	14	263-287	33-36	100
N35H	1170-1220	11.7-12.2	868	10.9	1353	17	263-287	33-36	120
N35SH	1170-1220	11.7-12.2	876	11.0	1592	20	263-287	33-36	150
N35UH	1180-1220	11.8-12.2	860	10.8	1990	25	263-287	33-36	180
N35EH	1170-1220	11.7-12.2	876	11.0	2388	30	263-287	33-36	200
N38	1220-1250	12.2-12.5	899	11.3	955	12	287-310	36-39	80
N38M	1220-1250	12.2-12.5	899	11.3	1114	14	287-310	36-39	100
N38H	1220-1250	12.2-12.5	899	11.3	1353	17	287-310	36-39	120
N38SH	1220-1250	12.2-12.5	907	11.4	1592	20	287-310	36-39	150
N38UH	1220-1250	12.2-12.5	899	11.3	1990	25	287-310	36-39	180
N38EH	1220-1250	12.2-12.5	899	11.3	2388	30	287-310	36-39	200
N40	1250-1280	12.5-12.8	907	11.4	955	12	302-326	38-41	80
N40M	1250-1280	12.5-12.8	923	11.6	1114	14	302-326	38-41	100
N40H	1250-1280	12.5-12.8	923	11.6	1353	17	302-326	38-41	120
N40SH	1240-1280	12.5-12.8	939	11.8	1592	20	302-326	38-41	150
N40UH	1240-1280	12.5-12.8	899	11.3	1990	25	302-326	38-41	180
N42	1280-1320	12.8-13.2	915	11.5	955	12	318-342	40-43	80
N42M	1280-1320	12.8-13.2	955	12.0	1114	14	318-342	40-43	100
N42H	1280-1320	12.8-13.2	955	12.0	1353	17	318-342	40-43	120
N42SH	1280-1320	12.8-13.2	987	12.4	1592	20	318-342	40-43	150
N45	1320-1380	13.2-13.8	923	11.6	955	12	342-366	43-46	80
N45M	1320-1380	13.2-13.8	995	12.5	1114	14	342-366	43-46	100
N45H	1320-1380	13.2-13.8	955	12.0	1353	17	342-366	43-46	120
N45SH	1320-1380	13.2-13.8	1003	12.6	1592	20	342-366	43-46	150
N48	1380-1420	13.8-14.2	923	11.6	955	12	366-390	46-49	80
N48M	1360-1430	13.6-14.3	1027	12.9	1114	14	366-390	46-49	100
N48H	1370-1430	13.7-14.3	995	12.5	1353	17	366-390	46-49	120
N50	1400-1450	14.0-14.5	796	10.0	876	11	382-406	48-51	60
N50M	1400-1450	14.0-14.5	1033	13.0	1114	14	382-406	48-51	100
N52	1430-1480	14.3-14.8	796	10.0	876	11	398-422	50-53	60



GRADE SPECIALI NdFeB SINTERIZZATO *SPECIAL-GRADE SINTERED NdFeB*

Alta Coercitività: $H_{cj} \geq 35kOe$

Bassa Reversibilità del Coefficiente di Temperatura:

$$\alpha Br = -0.08\%/^{\circ}C, \beta H_{cj} = -0.4\%/^{\circ}C$$

HAST Test: 125°C, 95%RH, 0.26MPa,

20Giorni, Perdita di peso $\leq 2mg/cm^3$

High Coercivity: $H_{cj} \geq 35kOe$

Low Reversible Temperature Coefficient:

$$\alpha Br = -0.08\%/^{\circ}C, \beta H_{cj} = -0.4\%/^{\circ}C$$

HAST Test: 125°C, 95%RH, 0.26MPa,

20Days, Weight Loss $\leq 2mg/cm^3$

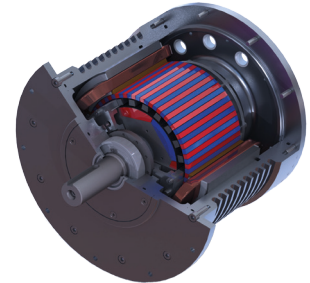

Materiale Grade	Induzione residua Remanence Br		Coercitività Coercivity Hc		Coercitività Intrinseca Intrinsic Coercivity Hci		Prodotto d'Energia Max. Energy Product BH _{MAX}		Temperatura max. di funzion. Max. Operating Temperature T _{MAX} °C
	mT	kGs	kA/m	kOe	kA/m	kOe	kJ/m ³	MGOe	
N30SH-II	1080-1120	10.8-11.2	851	10.7	1751	22	223-239	28-30	150
N35SH-II	1170-1210	11.7-12.1	915	11.5	1751	22	263-279	33-35	150
N38SH-II	1220-1250	12.2-12.5	947	11.9	1751	22	287-303	36-38	150
N40SH-II	1250-1290	12.5-12.9	971	12.2	1751	22	303-318	38-40	150
N42SH-II	1280-1320	12.8-13.2	987	12.4	1751	22	326-342	40-42	150
N33UH-II	1140-1170	11.4-11.7	875	11.0	2149	27	247-263	31-33	190
N35UH-II	1170-1210	11.7-12.1	915	11.5	2149	27	263-279	33-35	190
N38UH-II	1220-1250	12.2-12.5	947	11.9	2149	27	287-303	36-38	190
N33EH-II	1120-1170	11.2-11.7	876	11.0	2548	32	247-263	31-33	220
N40H-T	1250-1280	12.5-12.8	971	12.2	1432	18	303-318	38-40	120
N30SH-T	1080-1120	10.8-11.2	851	10.7	1711	21.5	223-239	28-30	150
N35SH-T	1170-1210	11.7-12.1	915	11.5	1830	23	263-279	33-35	150
N38SH-T	1220-1250	12.2-12.5	947	11.9	1830	23	287-303	36-38	150
N40SH-T	1250-1290	12.5-12.9	971	12.2	1830	23	303-318	38-40	150
N42SH-T	1280-1320	12.8-13.2	987	12.4	1830	23	326-342	40-42	150
N33UH-T	1120-1170	11.2-11.7	876	11.0	2149	27	247-263	31-33	190
N35UH-T	1170-1210	11.7-12.1	915	11.5	2149	27	263-279	33-35	190
N38UH-T	1220-1250	12.2-12.5	947	11.9	2149	27	287-303	36-38	190

ALTRE PROPRIETÀ *OTHER PERFORMANCE DATA*

Materiale Powder	Permeabilità relativa Relative Permeability μ_r	Temp. di Curie Curie Temperature T _c °C	Densità Density g/cm ³	Coefficiente termico Thermal Coefficient %/°C		Proprietà meccaniche Resistenza alla compressione Resistenza alla flessione Mechanical Properties Compressive resistance Bending resistance MPa	
				α_{Br}	β_{Hci}		
NdFeB	1.05	310	7.5	-0.12	-0.7	600-1200	150-380



SAMARIUM COBALT

SmCo are rare earth permanent magnets made from Sm, Co, Fe and other trace metal elements. Besides a high max. working temperature (up to 350°C), these grades have a remarkable resistance against corrosion, oxidation and demagnetization. Hence they are widely used in aeronautic and space industries.



SAMARIO - COBALTO

I magneti in Samario-Cobalto (SmCo) sono magneti permanenti in terre rare, composti da Samario, Cobalto, Ferro e tracce di altri metalli. Oltre a un'elevata temperatura di funzionamento (fino a 350°C), questi materiali presentano una notevole resistenza alla corrosione, all'ossidazione e alla smagnetizzazione. Per questo motivo trovano un ampio utilizzo nel campo aeronautico e spaziale.

Materiale Grade	Induzione residua Remanence B _r		Coercitività Coercivity H _c		Coercitività Intrinseca Intrinsic Coercivity H _{ci}		Prodotto d'Energia Max. Energy Product BH _{MAX}		Coefficiente termico Thermal Coefficient α _{Br} %/°C	Densità Density g/cm ³	Temp. di Curie Curie Temperature T _C °C	Temp. max. di funzion. Max. Operating Temperature T _{MAX} °C
	mT	kGs	kA/m	kOe	kA/m	kOe	kJ/m ³	MGOe				
YXG18	SmCo ₅	800	8.0	557	7.0	1194	15.0	127-143	-0.04	8.3	740	250
YXG20		850	8.5	621	7.8	1194	15.0	143-159				
YXG22		900	9.0	637	8.0	1194	15.0	159-175				
YXG22H		900	9.0	637	8.0	1432	18.0	159-175				
YXG24		950	9.5	677	8.5	1194	15.0	175-191				
YXG24	950	9.5	677	8.5	1432	18.0	175-191	-0.03	8.4	820	350	
YXG24H	950	9.5	677	8.5	1672	21.0	175-191					
YXG26	1000	10.0	716	9.0	1432	18.0	191-207					
YXG26H	1000	10.0	716	9.0	1672	21.0	191-207					
YXG28	1050	10.5	756	9.5	1432	18.0	207-223					
YXG28H	1050	10.5	756	9.5	1672	21.0	207-223					
YXG30	1080	10.8	796	10.0	1432	18.0	223-239					

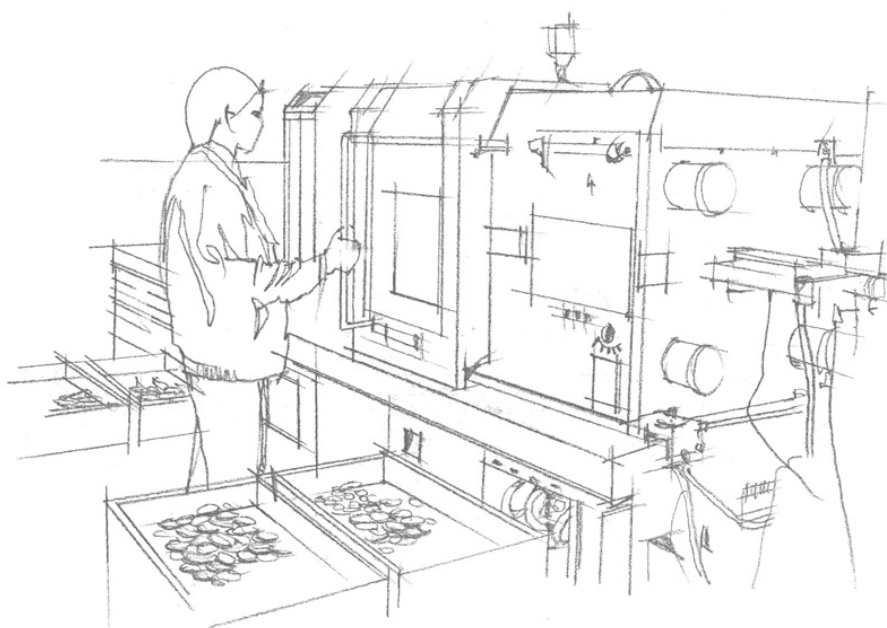

ALNICO



ALNICO

AlNiCo permanent magnets are an alloy made from Al, Ni, Co, Fe and other trace metal elements. They can be produced through either sintering (suitable for small and more complex parts) or more commonly casting process. These products have remarkable resistance against high temperatures and corrosion, and despite their poor resistance to demagnetisation, they are mainly used in certain precision instruments.

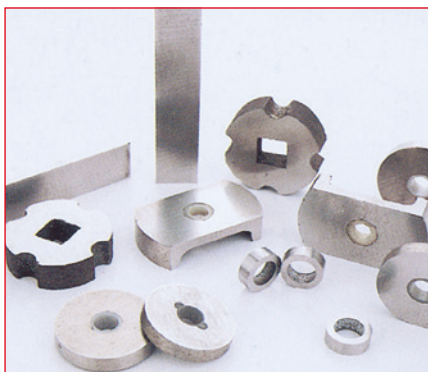

I magneti AlNiCo sono magneti permanenti, composti da una lega di Alluminio, Nichel e Cobalto, oltre a Ferro e altre tracce di elementi metallici. Questi magneti possono essere prodotti tramite un processo di sinterizzazione (per forme più piccole e complesse) o più comunemente di casting (fusione). Questi materiali hanno un'eccellente resistenza alle alte temperature e alla corrosione, e nonostante la bassa resistenza alla smagnetizzazione, sono principalmente usati in strumenti di precisione.

AlNiCo Sinterizzato - Sintered AlNiCo

Materiale Grade	Prodotto d'energia Max. Energy Product BH _{MAX}		Induzione residua Remanence B _r		Coercitività Coercivity H _c		Coercitività Intrinseca Intrinsic Coercivity H _i		Coefficiente termico Thermal Coefficient α _{Br} %/°C	Densità Density g/cm ³	Temp. di Curie Curie Temperature T _c °C	Nota Notes
	kJ/cm ³	MGOe	mT	Gs	kA/m	Oe	kA/m	Oe				
FLN8	8-10	1.0-1.25	520	5200	40	500	43	540	-0.020	6.7	760	Isotropo Isotropic
FLNG12	12-14	1.5-1.75	700	7000	40	500	43	540	-0.014	7.0	810	
FLNGT14	14-16	1.75-2.0	570	5700	76	950	78	980	-0.020	7.1	850	
FLNGT18	18-22	2.25-2.75	600	6000	95	1200	107	1350	-0.020	7.2	850	
FLNG28	28-33	3.5-4.15	1050	10500	46	580	47	590	-0.016	7.2	850	Anisotropo Anisotropic
FLNG34	34-38	4.3-4.8	1100	11000	50	630	51	640	-0.016	7.2	890	
FLNGT28	28-30	3.5-3.8	1000	10000	56	700	57	710	-0.020	7.2	850	
FLNG38J	38-40	4.75-5.0	730	7300	151	1900	163	2050	-0.020	7.2	850	
FLNGT38	38-42	4.75-5.3	800	8000	123	1550	126	1580	-0.020	7.2	850	
FLNG742	42-48	5.3-6.0	880	8800	120	1500	122	1530	-0.020	7.25	850	

AlNiCo Fuso - Cast AlNiCo

Materiale Grade	Classe MMPA Equivalent MMPA Class	Prodotto d'energia Max. Energy Product BH _{MAX}		Rimanenza Remanence B _r		Coercitività Coercivity H _c		Coefficiente termico Thermal Coefficient α _{Br} %/°C	Densità Density g/cm ³	Temp. di Curie Curie Temperat. T _c °C	Temp. max di funzion. Max. Operat. Temperature T _{MAX} °C	Nota Notes
		kJ/cm ³	MGOe	mT	Gs	kA/m	Oe					
LN9	Alnico1	9.0	1.13	680	6800	30	380	-0.03	6.9	760	450	Isotropo Isotropic
LN10		10.0	1.20	600	6000	40	500	-0.03	6.9	760	450	
LNG12	Alnico2	12.4	1.55	720	7200	45	500	-0.03	7.0	810	450	
LNG13		13.0	1.60	700	7000	48	600	-0.03	7.0	810	450	
LNG34	Alnico5	34.0	4.30	1200	12000	48	600	-0.02	7.3	860	525	Anisotropo Anisotropic
LNG37		37.0	4.65	1200	12000	48	600	-0.02	7.3	860	525	
LNG40	Alnico5DG	40.0	5.00	1250	12500	48	600	-0.02	7.3	860	525	
LNG44		44.0	5.50	1250	12500	52	650	-0.02	7.3	860	525	
LNG52	Alnico5-7	52.0	6.50	1300	13000	56	700	-0.02	7.3	860	525	
LNGT28	Alnico6	28.0	3.50	1000	10000	58	720	-0.025	7.3	860	550	
LNGT36J	Alnico8H	36.0	4.50	700	7000	140	1750	-0.025	7.3	860	550	
LNGT32	Alnico8	32.0	4.0	800	8000	100	1250	-0.025	7.3	860	550	
LNGT40		40.0	5.0	800	8000	110	1380	-0.025	7.3	860	550	
LNGT60	Alnico9	60.0	7.50	900	9000	110	1380	-0.025	7.3	860	550	
LNGT72		72.0	9.0	1050	10500	112	1400	-0.025	7.3	860	550	

SINTERED FERRITE



FERRITE SINTERIZZATA

Due to the manufacturing process and to their mechanical properties, sintered ferrites are also known as ceramic magnets. Ferrite powders (ferric oxide and either Strontium or Barium carbonate) are pressed in a magnetic field and then sintered. These magnets are available in many forms (cylinders, blocks, rings, segments...) and they have an excellent cost-performance ratio, and are therefore the most widely used magnets worldwide.



Grazie al processo produttivo e alle loro proprietà meccaniche, le ferriti sono anche note come magneti in ceramica. La polvere di ferrite (ossido di Ferro e carbonato di Stronzio - Sr - o Bario - Ba) viene pressata in un campo magnetico e in un secondo tempo viene sinterizzata. Disponibili in varie forme (cilindri, parallelepipedi, anelli, segmenti...), questi magneti offrono un ottimo rapporto qualità/prezzo, e costituiscono il gruppo di materiali magnetici più comunemente utilizzato.

Materiale Grade	Induzione residua Remanence Br mT	Coercitività Coercivity Hc kA/m	Coercitività Intrinseca Intrinsic Coercivity Hi kA/m	Prodotto d'Energia Max. Energy Product BHMAX kJ/m ³	Coefficiente termico Thermal Coefficient αBr %/°C	Permeab. revers. Reversible Permeability μO*μP mT	Densità Density g/cm ³	Temp. di Curie Curie Temperature Tc °C	Temp. max di funz. Max. Operating Temperature TMAX °C
HF 8/22 I BA	215	135	220	8	-0.20	~ 1.50	~ 4.8	~ 450	200
HF 24/16 a BA	350	155	160	24	-0.20	~ 1.35	~ 5.0	~ 450	200
HF 28/16 a BA	390	160	160	28	-0.20	~ 1.35	~ 5.0	~ 450	200
HF 26/24 a SR	370	230	240	26	-0.20	~ 1.35	~ 4.8	~ 450	200
HF 27/23 a SR	375	215	225	27	-0.20	~ 1.38	~ 4.8	~ 450	200
HF 28/26 a SR	385	250	260	28	-0.20	~ 1.35	~ 4.8	~ 450	200

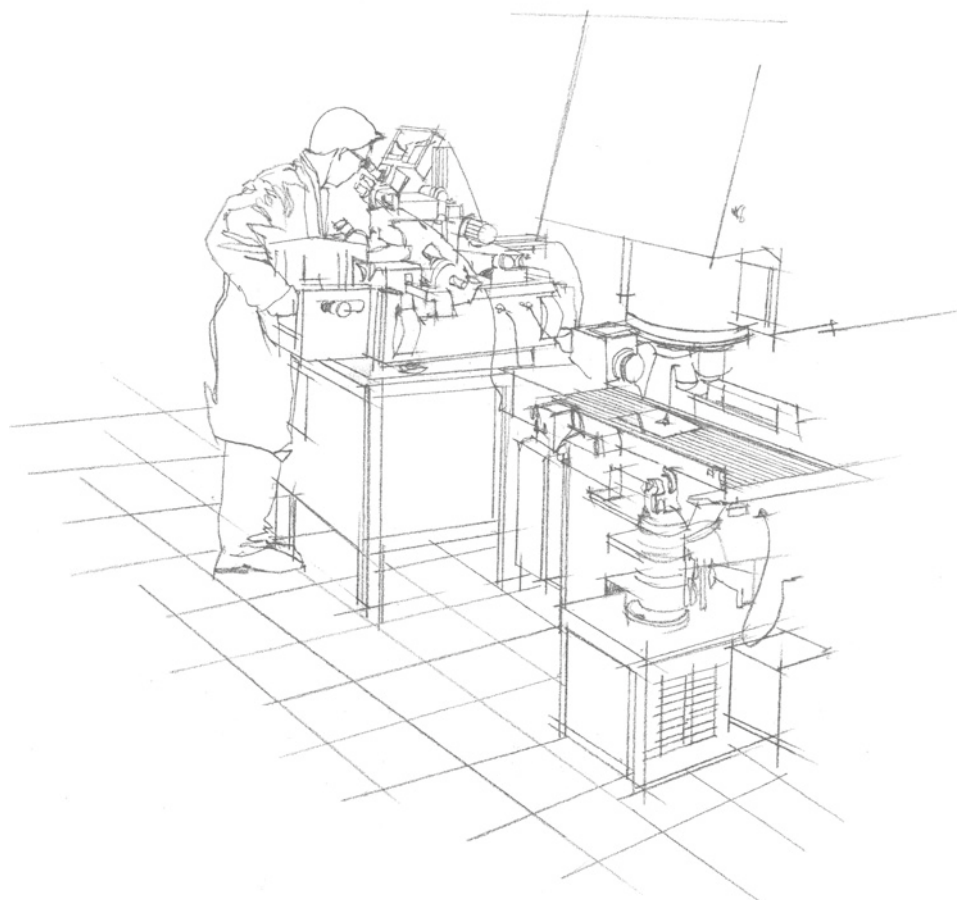

BONDED PLASTO-NEODYMIUM



These plasto-magnets are obtained through cold compression of NdFeB powders and thermoplastic elements.

This process allows the production of semi-complex shapes having good magnetic properties and dimensional accuracy, to be used at operating temperatures up to +150°C. In order to obtain a higher mechanical protection, it is possible to coat the bonded plasto-Neodymium with materials such as epoxy or Parylene.



PLASTO-NEODIMIO COMPRESSO

Questo tipo di plasto-magneti viene realizzato tramite processo di compressione a freddo di matrici termoplastiche e polveri di NdFeB.

Questo processo di formatura permette di realizzare forme semi-complesse con buone proprietà magnetiche, temperature di funzionamento fino a +150°C e precisione meccanica dimensionale. Per avere una maggiore protezione meccanica, è inoltre possibile rivestire il plasto-Neodimio compresso con materiali come resine epossidiche e Parylene.

Materiale Grade	Induzione residua Remanence Br		Coercitività Coercivity Hc		Coercitività Intrinseca Intrinsic Coercivity Hci		Prodotto d'Energia Max. Energy Product BH _{MAX}		Coefficiente termico Thermal Coefficient α _{Br} %/°C	Densità Density g/cm ³	Temp. di Curie Curie Temperature T _C °C	Temp. max. di funzion. Max. Operating Temperature T _{MAX} °C
	mT	kGs	kA/m	Oe	kA/m	Oe	kJ/m ³	MGOe				
B10 B	680	6.8	440	5530	720	9049	79	9.9	- 0.11	5.6 ÷ 6	360	150
B10 B+	700	7.0	465	5844	803	10092	81	10.2				
B10 C	635	6.35	444	5580	1200	15082	70	8.8				
B10 D	675	6.75	460	5781	850	10683	76	9.6				
SB 75	530	5.3	365	4587	730	9175	49	6.2				
SB 65	440	4.4	310	3896	730	9175	34	4.3				
SB 50	340	3.4	245	3079	780	9803	21	2.6				
SB 30	200	2.0	150	1885	780	9803	8	1.0				

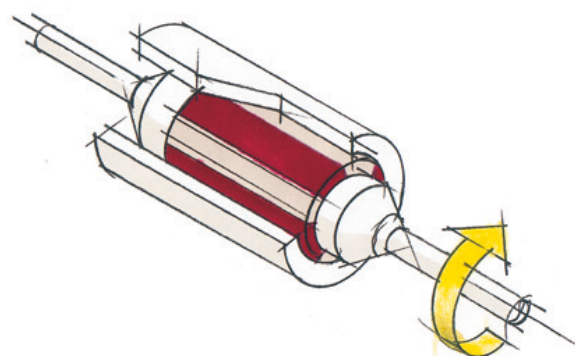

INJECTED PLASTO-NEODYMIUM



The production process of injected plasto-Neodymium mixes plastic elements with rare earth powders (Neodymium, Iron and Boron).

This type of magnet allows the production of complex shapes and overmoulding on existing materials, in order to obtain a complete system.

Plasto-Neodymium offers rather satisfactory magnetic performance, a good resistance to oxidation, corrosion and temperatures up to +120°C.



PLASTO-NEODIMIO INIETTATO

Il processo produttivo del plasto-Neodimio iniettato miscela matrici plastiche con polveri di terre rare (Neodimio, Ferro, Boro).

Con questi plastomagnetite è possibile realizzare geometrie complesse e sovrastampare su materiali esistenti per creare un sistema finito.

Il plasto-Neodimio presenta discrete proprietà magnetiche e una buona resistenza all'ossidazione, alla corrosione ed a temperature fino a +120°C.

Materiale Grade	Induzione residua Remanence Br		Coercitività Coercivity Hc		Coercitività Intrinseca Intrinsic Coercivity Hci		Prodotto d'Energia Max. Energy Product BHMAX		Temperatura max. di funzion. Max. Operating Temperature TMAX °C
	mT	Gs	kA/m	Oe	kA/m	Oe	kJ/m ³	MGOe	
32/64p1	447	4470	276	3460	640	8000	32	4.0	120
40/64p1	500	5000	300	3760	640	8000	40	5.0	120
48/66p2	550	5500	350	4300	660	8600	48	6.0	120
56/60p2	610	6100	338	4250	597	7500	56	7.0	100

	Forme Possibili Shape Possibilities	Sovrastampaggio Overmoulding	Tolleranze Tolerances	Temperatura Max Max Temperature
Isotropo Isotropic	Complesse Complex	Si Yes	0,01 ÷ 0,1 mm	+100 °C ÷ +120 °C
Anisotropo Anisotropic	Complesse Complex	Si Yes	0,01 ÷ 0,1 mm	+100 °C

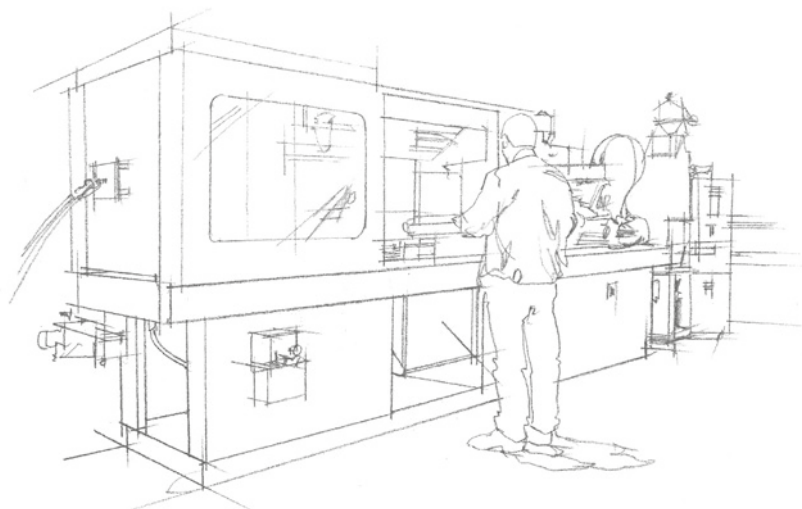

INJECTED PLASTO-FERRITE



PLASTO-FERRITE INIETTATA

Injected plasto-ferrite is obtained through injection moulding, by mixing plastic elements with ferrite oxides.

Thanks to this process it is possible to produce complex shapes with tight mechanical tolerances, thus allowing the accuracy and the mechanical precision of the final product, which is already magnetized and can be overmoulded on existing materials.



La plasto-ferrite iniettata è ottenuta tramite processo di stampaggio a iniezione, miscelando matrici plastiche con ossidi di ferrite.

Grazie a questo processo è possibile realizzare geometrie complesse mantenendo tolleranze dimensionali molto strette, aumentando l'accuratezza e la precisione meccanica del pezzo finito, già magnetizzato nella configurazione ottimale, con la possibilità di sovrastampare la plasto-ferrite su materiali esistenti.

Materiale Grade	Induzione residua Remanence Br		Coercitività Coercivity Hc		Coercitività Intrinseca Intrinsic Coercivity Hci		Prodotto d'Energia Max. Energy Product BHMAX		Temperatura max. di funzion. Max. Operating Temperature TMAX °C
	mT	Gs	kA/m	Oe	kA/m	Oe	kJ/m ³	MGOe	
3/17p1	130	1300	86	1080	173	2170	2.9	0.36	140
12/22p1	250	2500	175	2200	225	2830	12	1.5	150
14/21p1	287	2870	179	2250	215	2700	14.4	1.8	150
16/21p1	287	2870	179	2250	207	2600	16	2.0	150
14/22p2	275	2750	187	2350	223	2800	14.4	1.8	120
14/22p3	264	2640	179	2250	223	2800	13.6	1.7	180

	Forme Possibili Shape Possibilities	Sovrastampaggio Overmoulding	Tolleranze Tolerances	Temperatura Max Max Temperature
Isotropo Isotropic	Complesse Complex	Si Yes	0,01 ÷ 0,1 mm	+140 °C
Anisotropo Anisotropic	Complesse Complex	Si Yes	0,01 ÷ 0,1 mm	+120 °C ÷ +180 °C



MAGNETIC RUBBER



GOMMA MAGNETICA

Magnetic rubber is a flexible material which offers a desirable combination of good magnetic properties at lower cost. The flexibility and machinability of these materials permit their applications from simple holding and display products (advertising, decoration, design, toys...), through to technical ones such as permanent magnet motors and sensing.



La gomma magnetica è un materiale flessibile che offre una combinazione ideale di buone proprietà magnetiche e costo ridotto. La flessibilità di questi prodotti e la loro facile lavorazione permettono un ampio utilizzo nei campi che richiedono una funzione di fissaggio e display (esposizione) di prodotti (gadget pubblicitari, decorazione, design, giocattoli educativi ecc.) ma anche in settori più tecnici, quali l'utilizzo con sensori e motori.

MAGNETFLEX

Forma Shape	Dimensioni Dimensions	Spessore mm Thickness	Colore Colour	Forza di attraz. g/cm ² Attraction force
FOGLIO SHEET	500 x 600mm	0.6	bianco white	20
BOBINA ROLL	30mt x 620mm			

DECOFLEX

Forma Shape	Dimensioni Dimensions	Spessore mm Thickness	Colore Colour	Forza di attraz. g/cm ² Attraction force
FOGLIO SHEET	500 x 600mm 1000 x 600mm	0.8	bianco, blu, giallo, verde, rosso, nero white, blue, yellow, green, red, black	35
BOBINA ROLL	30mt x 25-30-50-80-100mm	0.8	bianco (standard) altri colori a richiesta white (standard) other colours on request	35
	30mt x 620mm	0.8	bianco lucido/opaco gloss/matt white	35

FLEXAMAGNET

Forma Shape	Dimensioni Dimensions	Spessore mm Thickness	Versione Version	Forza di attraz. g/cm ² Attraction force
FOGLIO SHEET	500 x 600mm	0.5	standard / adesivo plain / self adhesive	20
BOBINA ROLL	30mt x 620mm	0.5	standard plain	20

FLEXAM / FLEXOR

Tipo Type	Dimensioni Dimensions	Spessore mm Thickness	Versione Version	Forza di attraz. g/cm ² Attraction force
FLEXAM	500 x 600mm	0.7	standard / adesivo plain / self adhesive	35
	30mt x 620mm	0.7	standard plain	35
	500 x 640mm	1.0/1.5	standard / adesivo plain / self adhesive	40/55
	500 x 320mm	1.5/2.0	magnetizzato 2 facce magnetised 2 faces	55/65
FLEXOR	500 x 640mm	1.0/1.5/2.0	standard / adesivo plain / self adhesive	60/80/110
	500 x 320mm	1.0/1.5/2.0	magnetizzato 2 facce magnetised 2 faces	60/80/100
	30mt x 12.7-19-25.4-50mm	1.5	adesivo self adhesive	80
	25mt x 13-20-30-50mm	1.5	standard plain	80

PLACAM 8D / PLACOR 15

Tipo Type	Dimensioni Dimensions	Spessore mm Thickness	Versione Version	Forza di attraz. g/cm ² Attraction force
PLACAM 8D	500 x 640mm	1.5	standard plain	90
	500 x 320mm	2.5	standard plain	140
PLACOR 15	500 x 320mm	1.5	standard plain	120
	500 x 320mm	2.5	standard plain	180
	500 x 320mm	2.5	film protettivo su lato magn. protective film on magnetic face	140

CARTA MAGNETICA MAGNETIC PAPER

RU250A-M	Carta magnetica formato A4 per stampanti Inkjet A4 magnetic paper for Inkjet printers			
----------	---	--	--	--



TIPI DI MAGNETIZZAZIONE TYPES OF MAGNETISATION



SEGMENTED
RADIAL

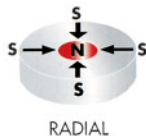

RADIAL

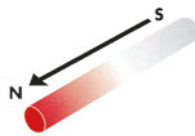

LONGITUDINAL
AXIAL



PERIPHERAL
MULTIPOLAR

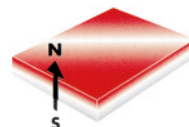

AXIAL THROUGH
THE THICKNESS



INTERIOR/EXTERIOR
MULTIPOLAR

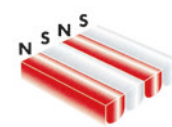

1-FACE
MULTIPOLAR

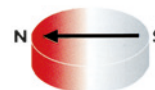

DIAMETRAL

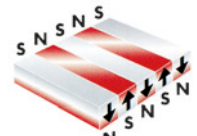

2-FACE
MULTIPOLAR



FRONTAL
MULTIPOLAR

GLOSSARIO GLOSSARY

Anisotropia magnetica: dipendenza delle proprietà magnetiche di un materiale magnetico dalla direzione di campo applicata. Un magnete anisotropo ha una direzione preferenziale di magnetizzazione che consente l'ottimizzazione delle caratteristiche magnetiche.

Anisotropy: during manufacture a magnet can be given a preferred direction of magnetic orientation, usually by an external field. This increases the magnetic properties significantly, but limits the magnetisation to one axis.

Coefficiente termico di reversibilità: misura la variazione reversibile delle proprietà magnetiche in funzione della variazione della temperatura.

Thermal (or Temperature) Coefficient: a measure of the reversible changes in flux caused by temperature variations.

Coercitività (Hc): misurata in Oersted, è la forza di smagnetizzazione necessaria per ridurre a zero l'induzione B di un materiale magnetico saturato.

Coercivity (Hc): the demagnetising force, measured in Oersted, necessary to reduce observed induction B to zero after the magnet has previously been brought to saturation.

Coercitività intrinseca (Hci): misurata in Oersted, è il campo di smagnetizzazione necessario per ridurre a zero l'induzione intrinseca di un magnete saturato. È usata come misura della resistenza di un materiale magnetico alla smagnetizzazione: più alto è il suo valore e maggiore sarà la stabilità delle caratteristiche magnetiche del materiale.

Intrinsic coercivity (Hci): measured in Oersteds, this is a measure of the material's inherent ability to resist demagnetization. It is the demagnetization force corresponding to zero intrinsic induction in the magnetic material after saturation. Practical consequences of high Hci values are seen in greater temperature and material stability.

Flusso magnetico: la concentrazione delle linee di forza per unità di area che passano da un polo all'altro.

Flux density: the concentration of lines of force per unit area passing from one pole to the other.

Forza coercitiva: Vd. Coercitività.

Coercive force: see Coercivity.

Forza coercitiva intrinseca: Vd. Coercitività intrinseca.

Intrinsic coercive force: see Intrinsic coercivity.

Induzione residua (Br): forza magnetica presente su un materiale dopo la magnetizzazione.

Remanence (Br): the magnetic induction remaining in a material after removal from an external field.

Induzione (B): il flusso magnetico per unità di area di una sezione perpendicolare alla direzione del flusso.

Induction (B): the magnetic flux per unit area of a section normal to the direction of flux.

Isotropia magnetica: indipendenza delle caratteristiche magnetiche dalla direzione del campo applicato. Un magnete isotropo può essere magnetizzato in qualsiasi direzione mantenendo stabili le sue caratteristiche magnetiche.

Isotropy: a magnet material whose magnetic properties are the same in any direction, and which can therefore be magnetized in any direction without loss of magnetic characteristics.

Max. Prodotto d'Energia (BHMAX): il punto del ciclo d'isteresi nel quale la forza di magnetizzazione H e l'induzione B raggiungono il massimo valore.

Energy Product (BHMAX): mainly used as a means of comparing magnetic materials. It is the point on the demagnetising curve at which the product of remanent induction and the demagnetising field is at a maximum.

Permeabilità magnetica (μ): quantifica gli effetti della presenza di un materiale magnetico. È espressa come il rapporto tra l'induzione B e il campo magnetico H: $\mu=B/H$.

Permeability (μ): the general term to express the relationship between magnetic flux density and applied magnet field strength, i.e. the instantaneous value of B/H.

Permeabilità relativa (μr): il rapporto tra la permeabilità di un materiale e la permeabilità a vuoto: $\mu_r=\mu/\mu_0$.

Relative permeability (μr): the ratio of permeability of a medium to that of the vacuum: $\mu_r=\mu/\mu_0$.

Temperatura di Curie (Tc): temperatura al di sopra della quale i magneti si smagnetizzano (tutte le perdite diventano irreversibili).

Curie Temperature (Tc): this is the temperature at which the magnetic properties are nullified.

Unità di misura: sono generalmente usati due sistemi di misurazione, CGS e SI, quest'ultimo più conosciuto a livello internazionale.

Units of measurement: two systems are used, CGS and, more internationally recognised SI.

	CGS	SI	Conversione Conversion
Br	Gauss (G) o (Gs)	milli Tesla (mT)	1 Gauss = 0.1 mT
H	Oersteds (Oe)	kilo Ampere/meters (kA/m)	1 Oersted = 0.07958 kA/m
BHMAX	Mega Gauss Oersteds (MGOe)	kilo Joules/meters ² (kJ/m ²)	1MGOe = 7.96 kJ/m ²



garnet

Garnet Srl

Via Magellano 14 - 20863 Concorezzo (MB)
Tel. +39 039 6886158 - Fax +39 039 6908081
info@garnet.it - www.garnet.it

garnet